

PRODUITS PRECONISES PSA - RENAULT

ELECTRODISTRIBUTEURS PLAN DE POSE ISO 5599/1 SERIE ISV CONNECTEUR M12

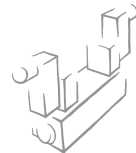

CARACTERISTIQUES TECHNIQUES	ISO 1	ISO 2
Pression d'utilisation:		
• monostable	2.5 à 10 bar	
• bistable	1 à 10 bar	
• pilotage externe	vide à 10 bar	
Pression minimum de pilotage	2.5 bar	
Température de fonctionnement	-10° à +60°C	
Diamètre nominal	7.5 mm	12 mm
Conductance C	250 NI/min · bar	657.14 NI/min · bar
Ratio critique b	0.36 bar/bar	0.25 bar/bar
Débit nominal à 6 bar ΔP 0.5 bar	700 NI/min	1800 NI/min
Débit nominal à 6 bar ΔP 1 bar	1100 NI/min	2700 NI/min
TRA / TRR monostable à 6 bar	22 ms / 60 ms	78 ms / 180 ms
Pilote électrique:	Avec bobine intégrée	
Commande manuelle:	Monostable sur l'électropilote Monostable sur le corps du distributeur	
Puissance	1,2 W	
Tension	24 VDC ±10%	
Connexion électrique M12	M12	
Degré de protection	IP65 EN60529	
Protection électrique	Transil	



2

5/2 MONOSTABLE ISO 1

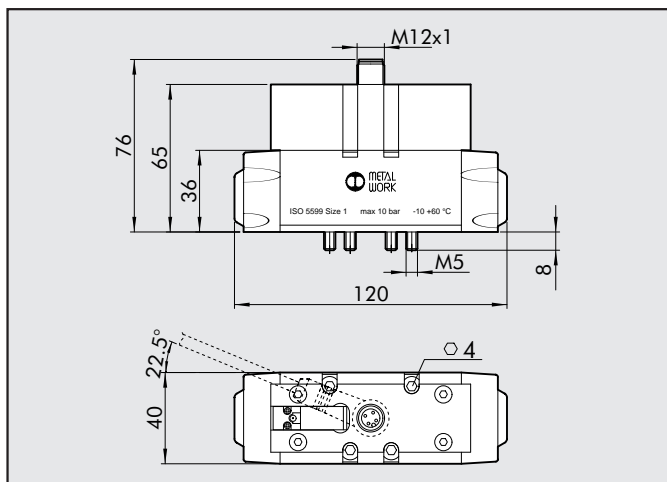

Symbole	Type	Code	Poids [g]
	ISV 55 COS OO	7054021100	508
	ISV 55 CES OO	7054021400	508

5/2 MONOSTABLE ISO 2

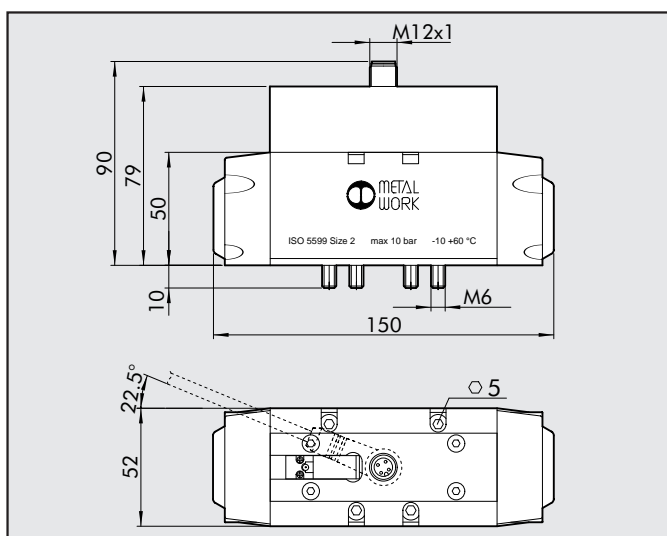





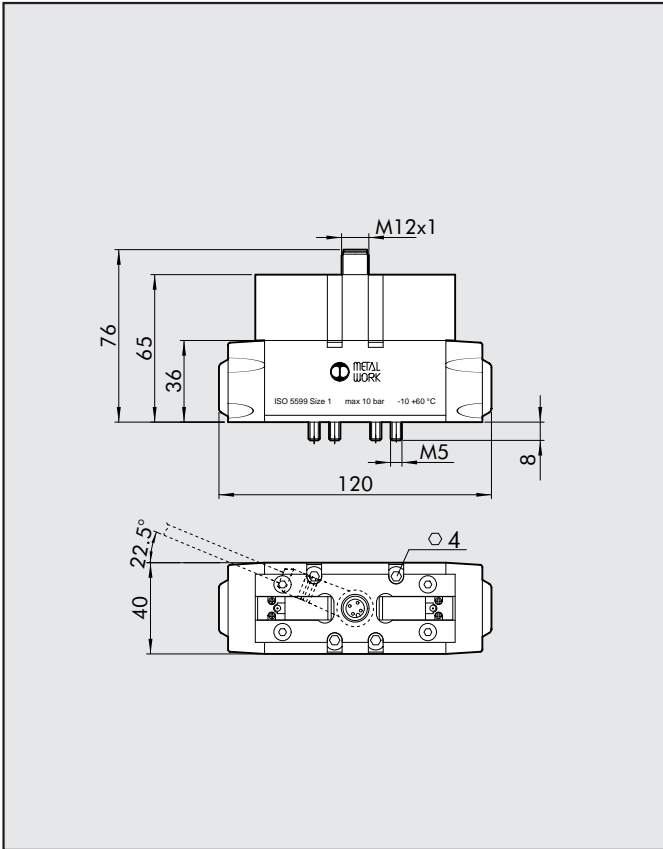

Symbole	Type	Code	Poids [g]
	ISV 65 COS OO	7055021100	901
	ISV 65 CES OO	7055021400	901

ELECTRODISTRIBUTEURS PLAN DE POSE ISO 5599/1 SERIE ISV CONNECTEUR M12



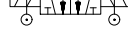
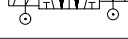
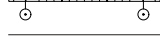



5/2 BISTABLE ISO 1
5/3 ISO 1

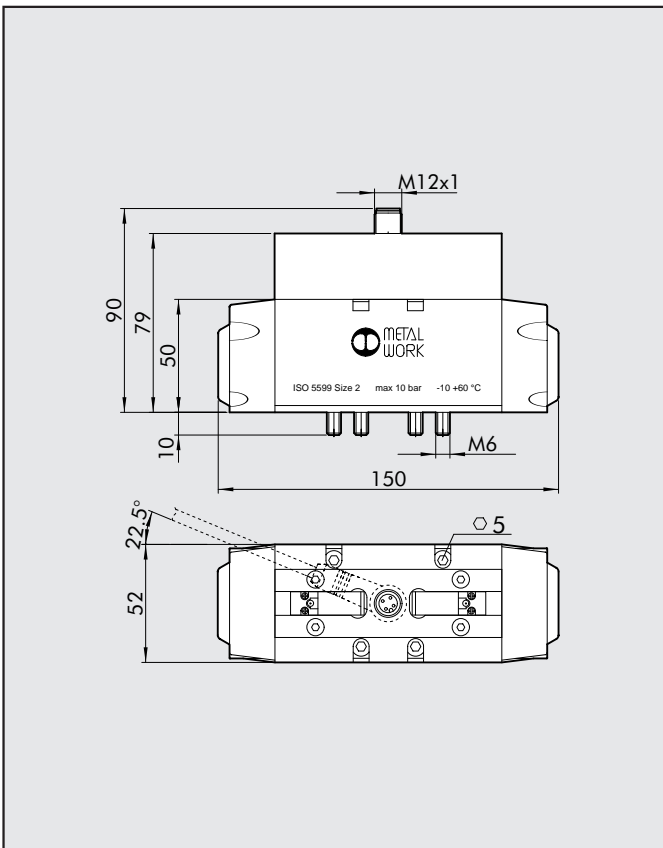

Symbole	Désignation	Code	Poids [g]
	ISV 55 COB OO	7054021200	512
	ISV 55 COD OO	7054021300	490
	ISV 56 COS CC	7054022100	496
	ISV 56 COS OC	7054022200	496
	ISV 56 COS PC	7054022300	496
	ISV 55 CEB OO	7054021500	512
	ISV 55 CED OO	7054021600	490
	ISV 56 CES CC	7054022400	496
	ISV 56 CES OC	7054022500	496
	ISV 56 CES PC	7054022600	496

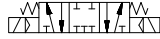
5/2 BISTABLE ISO 2
5/3 ISO 2

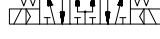
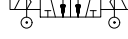
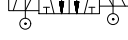

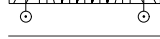
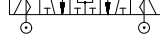
Symbole	Désignation	Code	Poids [g]
	ISV 65 COB OO	7055021200	860
	ISV 65 COD OO	7055021300	860
	ISV 66 COS CC	7055022100	868
	ISV 66 COS OC	7055022200	868
	ISV 66 COS PC	7055022300	868
	ISV 65 CEB OO	7055021500	860
	ISV 65 CED OO	7055021600	860
	ISV 66 CES CC	7055022400	868
	ISV 66 CES OC	7055022500	868
	ISV 66 CES PC	7055022600	868

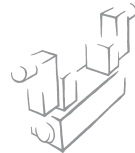

PRODUITS PRECONISES PSA - RENAULT

SCHEMA ELECTRIQUE

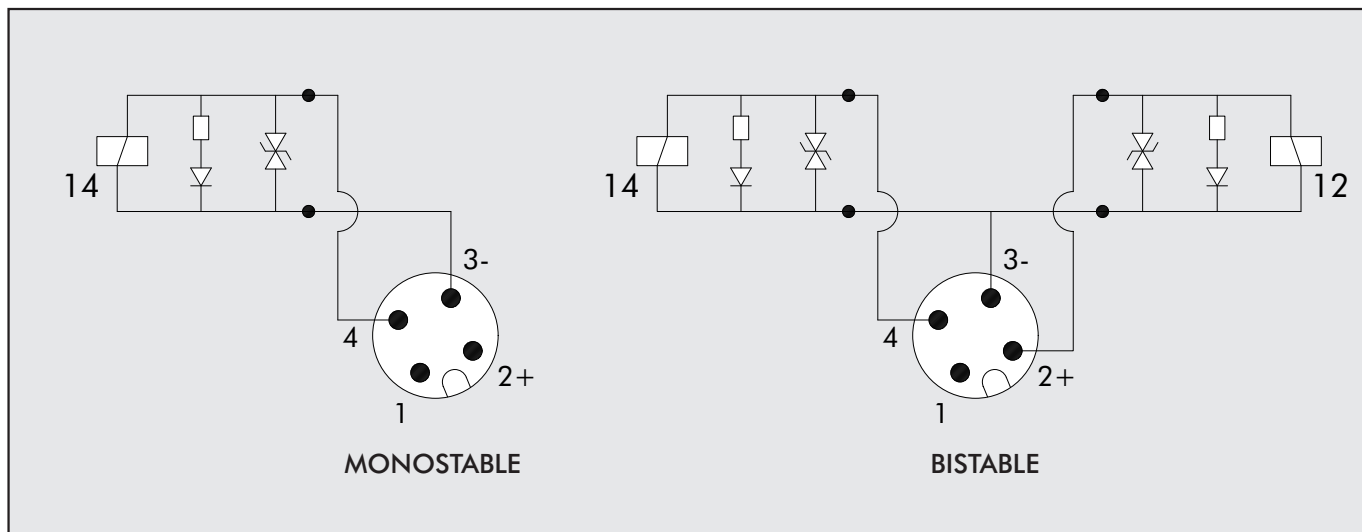

2

NOTES

Blank area for notes, consisting of multiple horizontal lines.